

DASH
OFFROAD

PATROL Y62
3 PEICE
MODULAR FLOOR

INSTALLATION
INSTRUCTIONS

Patrol Y62 Modular Floor

INSTALLATION INSTRUCTIONS

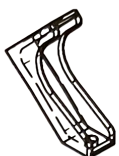
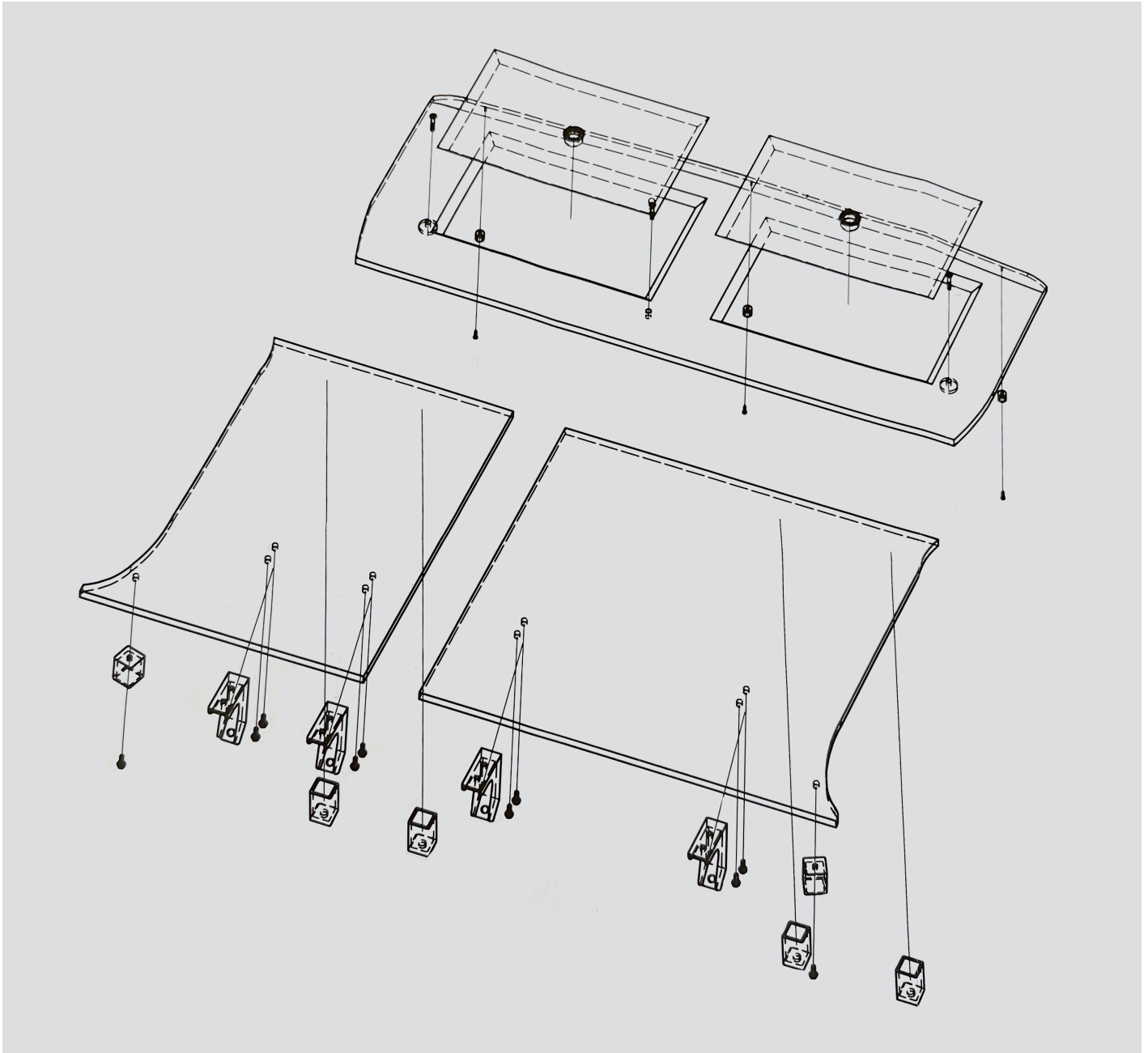

4 X SUPPORT BRACKET



10 X M6X20MM BOLTS



2 X SIDE SUPPORT



3 X REAR SPACER



3 X SELF TAPPING SCREWS



3 X COUNTERSUNK HEAD BOLTS

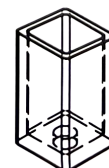

4 X MID BRACKETS

Patrol Y62 Modular Floor

INSTALLATION INSTRUCTIONS



1. Unbolt and remove the floor access lid.

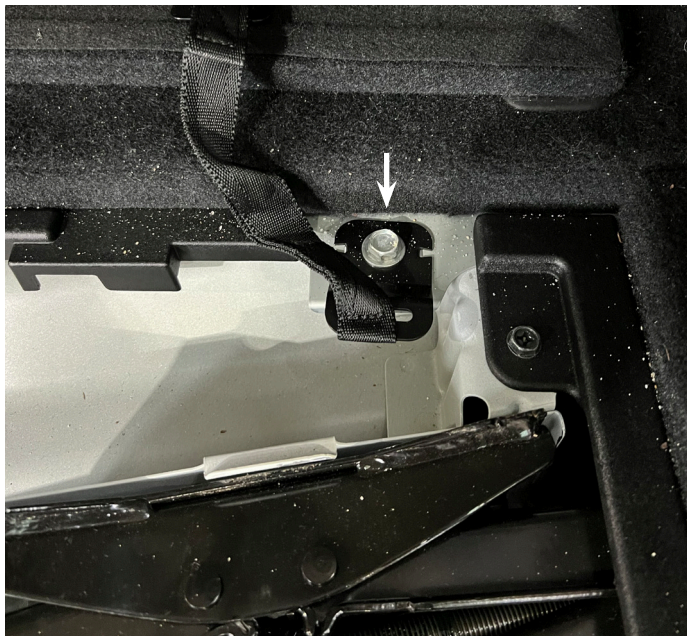

2. Unbolt and remove the 2 side panels

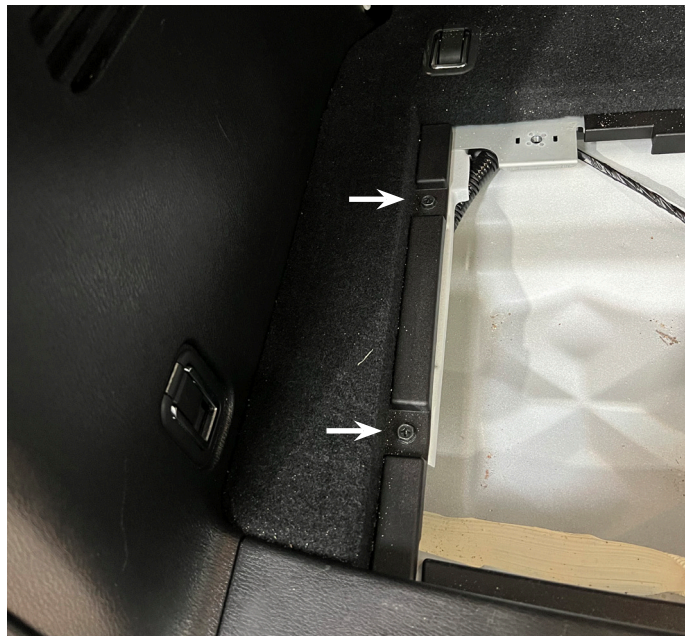

3. Remove the tiedown points - lift the tiedown and then fold the black cover back to reveal the bolt



4. Fold the seat covers up and pop off.

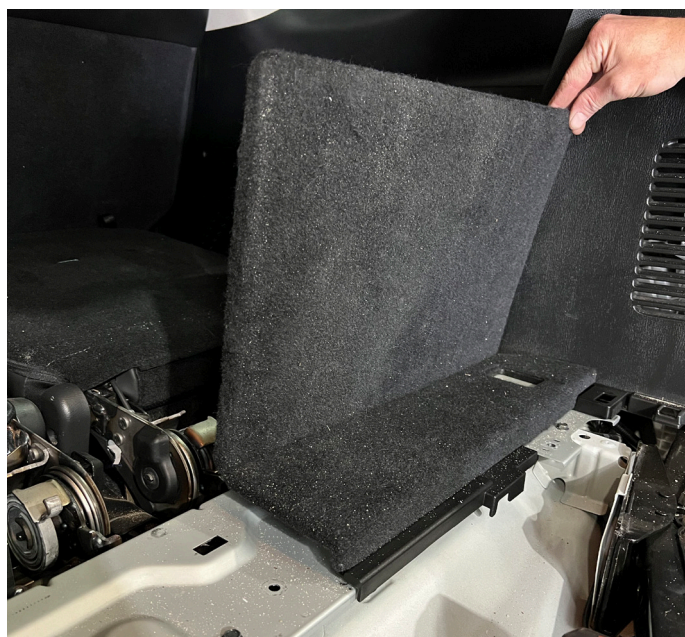

Patrol Y62 Modular Floor

INSTALLATION INSTRUCTIONS



5. Remove the metal support panel

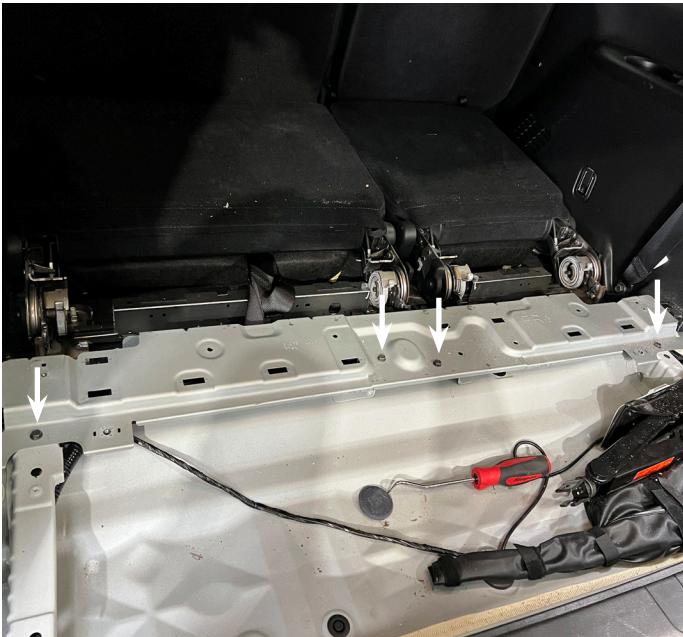

6. Unbolt the back of the seats and the centre seat belt mount

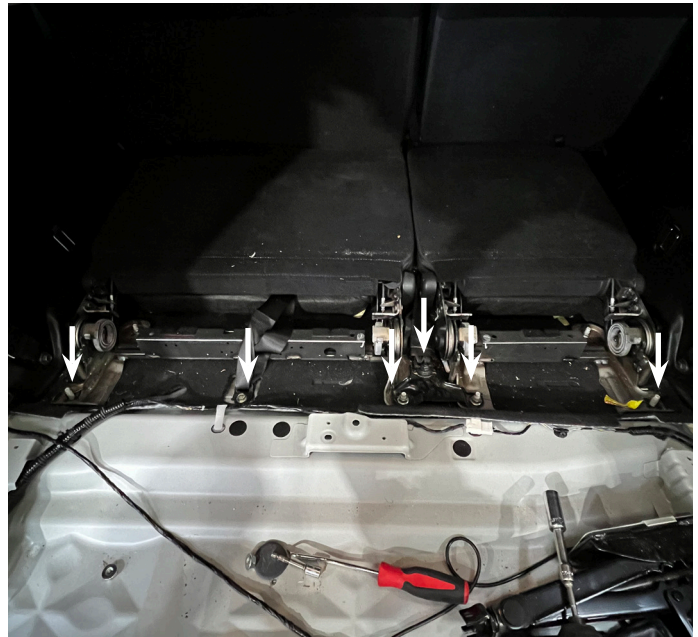

7. Unclip the plastic covers and remove the 4 front seat bolts. You can now remove the 3rd row seats.



8. Screw the 3 smaller spacers to the base of the back floor panel



Patrol Y62 Modular Floor

INSTALLATION INSTRUCTIONS



9. Bolt the 4x Mid brackets to the floor with the factory nuts that were removed from the seats.
Note: these brackets are angled at the top and need to have the higher side towards the front of the car.



10. Loosly screw the back panel in place with the 3 M6x40mm Hex Socket bolts.



Patrol Y62 Modular Floor

INSTALLATION INSTRUCTIONS



12. Bolt the Side supports and the Support brackets to the bottom of the front panels with the M6X20mm Bolts.



13. Slide the front panels in so that they tuck under the rear panel



Patrol Y62 Modular Floor

INSTALLATION INSTRUCTIONS



14. Once both panels are in place adjust all 3 panels so they align and tighten all bolts.

